

Electric Door Strike with Vertical Adjustment

SD-996C-U1VQ

12 VDC/VAC, Fail-Safe or Fail-Secure

Features:

- Vertical adjustable deadbolt opening, sliding shim keeper, and deadlatch ramp accommodates a wide range of lock types
- Accommodates deadbolts up to 1"
- Field selectable for fail-safe or fail-secure
- Reversible non-handed design fits either right-hand or left-handed doors
- Includes 5 different stainless-steel faceplates
- Includes trim plate to hide gaps in installation
- 1,500-lb holding force
- 12 VDC/VAC
- Tested to 1 million cycles
- Low current draw
 - 250mA@12VDC

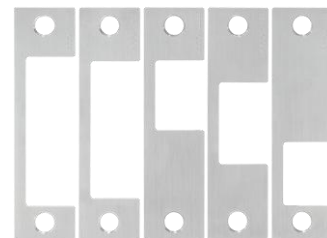

Five Faceplates Included
(see back for details)

Specifications:

Model	SD-996C-U1VQ
Operating voltage	12VDC/VAC $\pm 15\%$
Current draw	250mA@12VDC
Operating temperature	14°F~113°F (-10°~45° C)
Operating humidity	0~95%
Jaw Strength	1,500-lb
Latch throw	1" (25mm) max with 1/8" (3mm) door gap
Dimensions	1 13/16" x 1 5/8" x 3 5/16" (47x42x84 mm)
Weight	1-lb 5.8-oz (618g)

Dimensions:

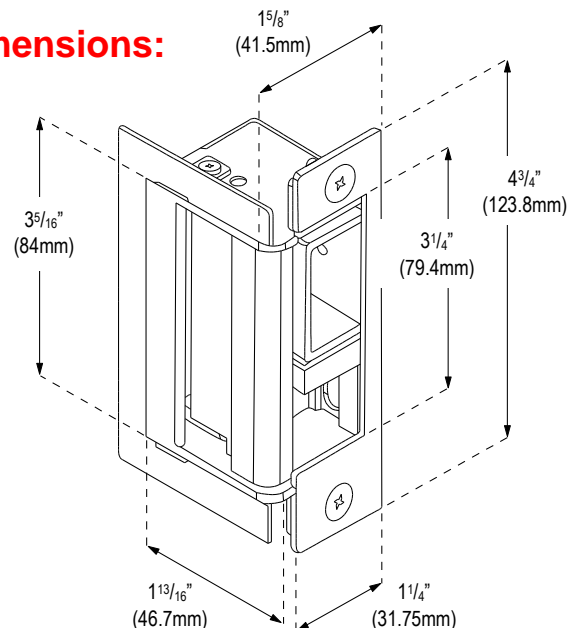

Faceplates:

SD-996SS-11D1Q

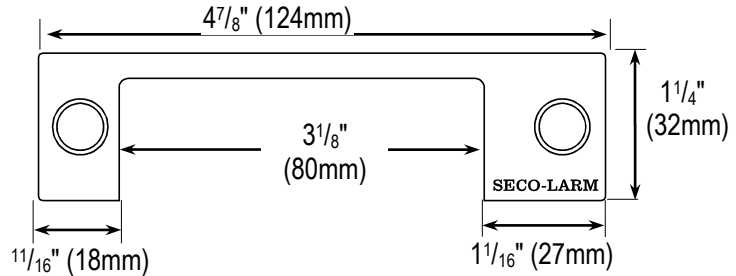
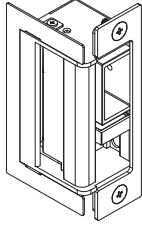

SD-996SS-11D2Q

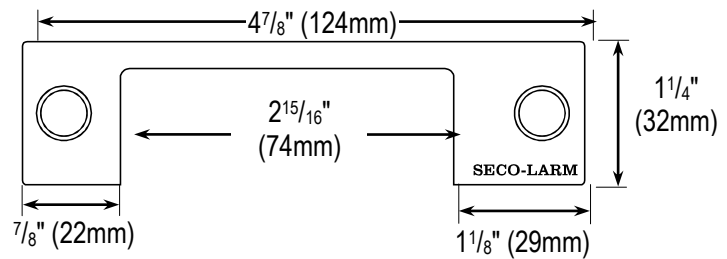
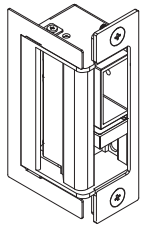

SD-996SS-11L1Q

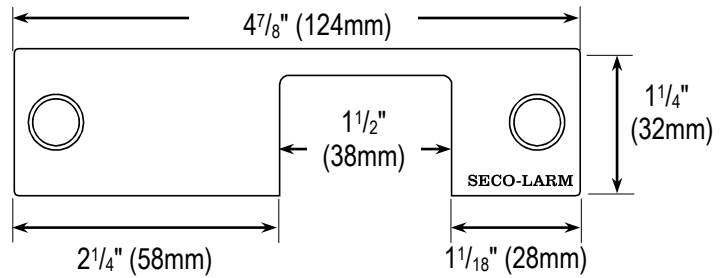
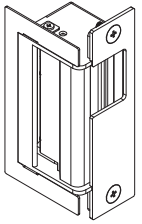

SD-996SS-11L2Q

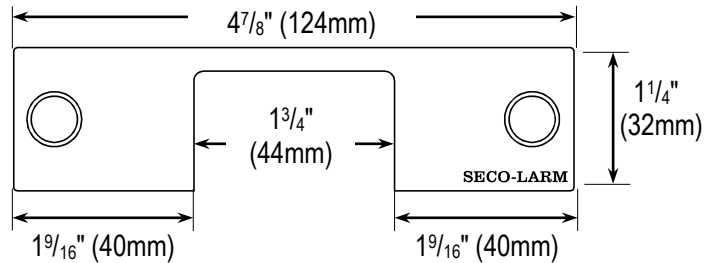
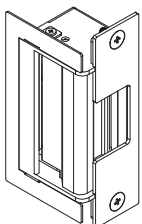

SD-996SS-11L3Q

