

# ENFORCER®

## Indoor Monitor Bracket

### Manual



- Indoor monitor bracket that allows the DP-264-M7Q to be placed on a desk
- Compatible with DP-264-1C7Q & DP-264-M7Q
- Adjustable up to 3" off the table

### Parts List

1x Indoor monitor bracket	4x Screws
4x Nuts	1x Manual



### Overview

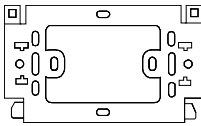

Use the monitor mounting bracket (wall-mount bracket) included in the DP-264-1C7Q & DP-264-M7Q

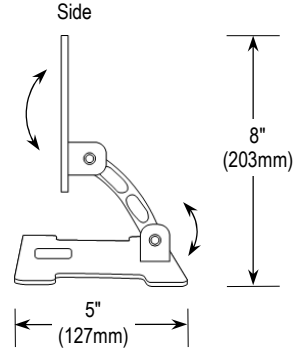
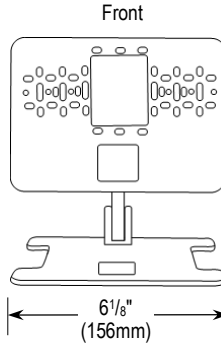

### Installation

Please read the manual carefully before you begin the installation.

1. Use the monitor mounting bracket provided with the DP-264-M7Q or DP-264-1C7Q to mount the monitor to the indoor monitor bracket.
2. Left mounting best centers the monitor on the stand.

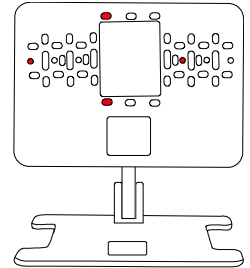

**California Proposition 65 Warning:** These products may contain chemicals which are known to the State of California to cause cancer and birth defects or other reproductive harm. For more information, go to [www.P65Warnings.ca.gov](http://www.P65Warnings.ca.gov).

**WARRANTY:** This SECO-LARM product is warranted against defects in material and workmanship while used in normal service for one (1) year from the date of sale to the original customer.

**NOTICE:** The SECO-LARM policy is one of continual development and improvement. For that reason, SECO-LARM reserves the right to change specifications without notice. SECO-LARM is also not responsible for misprints. All trademarks are the property of SECO-LARM U.S.A., Inc. or their respective owners. Copyright © 2022 SECO-LARM U.S.A., Inc. All rights reserved.

## SECO-LARM® U.S.A., Inc.

16842 Millikan Avenue, Irvine, CA 92606  
Phone: (949) 261-2999 | (800) 662-0800

Website: [www.seco-larm.com](http://www.seco-larm.com)  
Email: [sales@seco-larm.com](mailto:sales@seco-larm.com)

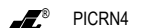

MI\_DP-264-MSQ\_220118.docx

## Soporte Para Monitor Interior

DP-264-MSQ

Manual



ES



- Soporte de monitor interior que permite colocar el DP-264-M7Q en un escritorio
- Compatible con el DP-264-1C7Q y DP-264-M7Q
- Ajustable hasta 3" fuera de la mesa

### Lista de Partes

- 1x Soporte para monitor interior  
4x Tornillos  
4x Nuts  
1x Manual

### Visión General

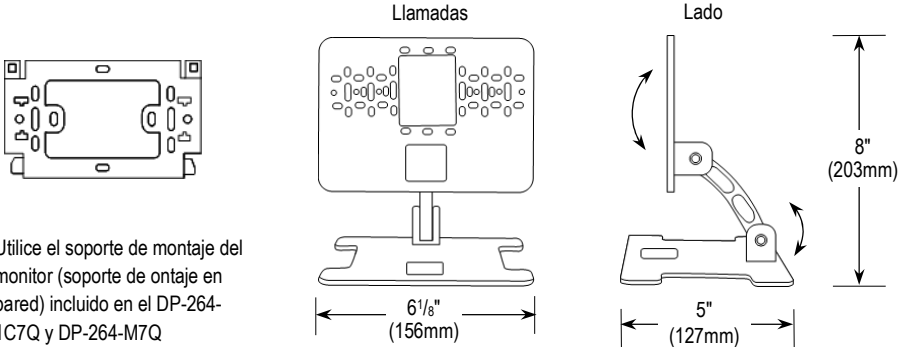

### Instrucciones de Instalación

Por favor lea el manual antes de usar el equipo.

1. Utilice el soporte de montaje del monitor suministrado con el DP-264-M7Q o DP-264-1C7Q para montar el monitor en el soporte del monitor interior.
2. El montaje izquierdo centra mejor el monitor en el soporte

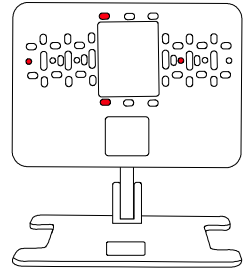

**Advertencia de la Propuesta 65 de California:** Estos productos pueden contener sustancias químicas que el estado de California reconoce como causantes de cáncer y defectos de nacimiento u otros daños reproductivos. Para obtener más información, visite [www.P65Warnings.ca.gov](http://www.P65Warnings.ca.gov).

**GARANTÍA:** Este producto SECO-LARM está garantizado contra defectos en materiales y mano de obra mientras se usa en servicio normal durante un (1) año desde la fecha de venta al cliente original.

**AVISO:** La póliza de SECO-LARM es de desarrollo y mejora continua. Por esa razón, SECO-LARM se reserva el derecho de cambiar las especificaciones y los precios sin previo aviso. SECO-LARM tampoco es responsable de errores de impresión. Todas las marcas comerciales son propiedad de SECO-LARM U.S.A., Inc. o sus respectivos propietarios. Copyright © 2022 SECO-LARM U.S.A., Inc. Todos los derechos reservados.

**SECO-LARM® U.S.A., Inc.**

16842 Millikan Avenue, Irvine, CA 92606  
Phone: (949) 261-2999 | (800) 662-0800

Website: [www.seco-larm.com](http://www.seco-larm.com)  
Email: [sales@seco-larm.com](mailto:sales@seco-larm.com)

PICRN4

ML\_DP-264-MSQ\_220118.docx