

SECO-LARM®

Electromagnetic Locks

With LED, Bond Sensor

E-941SA-600PQ 600-lb. (272kg)

E-941SA-1K2PQ 1200-lb. (545kg)



Weatherproof

E-941SA-300 300-lb. (136kg)*

Manual



*E-941SA-300 is not UL listed.

SECO-LARM® SLI™



SECO-LARM Electromagnetic Locks

Table of Contents:

Introduction	2	Installation	4-6
Features	2	Wiring Diagram	7
Parts List	2	Maximum Wiring Distance	7
Specifications	2	Troubleshooting	8
Overview and Installation Applications	3	Warranty	8

Introduction:

The E-941SA series of electromagnetic locks is the ideal way to secure a door against unauthorized entry. When power is applied to the electromagnetic lock, it creates an extremely strong magnetic field. The electromagnet is strongly attracted to the steel armature plate which is mounted on the secured door. Once the electromagnet is deactivated, the secured door will function normally without any residual magnetism.

Features:

- Anodized aluminum.
- No residual magnetism.
- MOV surge protection.
- Adjustable mounting bracket.
- Complete mounting hardware for typical installations.
- "L" bracket and "Z" brackets available for easy mounting.*
- 12/24VDC selectable.*
- Detachable faceplate.*

E-941SA-1K2PQ and **E-941SA-600PQ** also feature:

- Built-in dual-colored status LED and bond sensor to show locking status:

Green	Door is closed and locked
Red	Door not closed and/or locked
Off	Door in use / No power

E-941SA-300 features:

- Weatherproof for outdoor use.
- Pre-installed 36" (91cm) hookup wire included.

*E-941SA-300 does not have this feature.

Parts List:

- 1 x Mounting plate
- 1 x Electromagnet
- 1 x Armature plate
- 1 x Armature screw
- 2 x Steel washers
- 1 x Rubber washer
- 1 x Door spacer
- 1 x Sexnut bolt
- 2 x Guide pins
- 4 x Long self-tapping screws
- 2 x Short self-tapping screws
- 2 x Hex-head mounting screws
- 2 x Tamper caps
- 2 x Hex wrenches

Specifications:

		300-lb	600-lb	1,200-lb
Operating voltage		12VDC ±10%	12 or 24 VDC ±10%	
Current draw	12VDC	315mA@	500mA	
	24VDC	N/A	250mA	
Coil resistance		38Ω±10%	48Ω±10%(see page 8)	
Bond sensor relay		N/A	3A@12VDC	
Dimensions	Magnet	6 ³ / ₄ "x1"x1 ¹ / ₄ " (170x23x32 mm)	9 ⁷ / ₈ "x1 ¹ / ₁₆ "x1 ⁵ / ₈ " (250x26x40 mm)	10 ¹ / ₂ "x1 ⁵ / ₈ " x2 ⁵ / ₈ " (268x42x67 mm)
	Armature plate	6 ¹ / ₄ "x9 ⁹ / ₁₆ "x1 ⁵ / ₈ " (159x14x41 mm)	7 ¹ / ₄ "x1 ¹ / ₂ "x1 ¹ / ₂ " (185x12x38 mm)	7 ¹ / ₄ "x5 ⁵ / ₈ "x2 ³ / ₈ " (185x16x61 mm)
Operating temperature		14°~131° F (-10°~55° C)		
Weight		2-lb 13.5-oz (1.3kg)	4-lb 6-oz (2kg)	11-lb (5kg)
UL Listed		No	Yes	Yes

Overview:

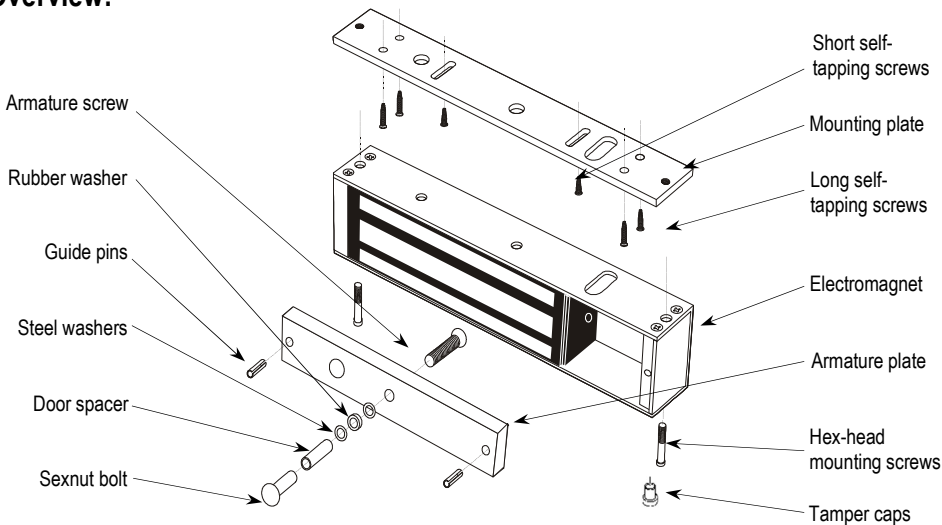

Installation Applications:

NOTE: When mounting the electromagnet, it may be necessary to use a "Z"-bracket, 1 or 2 "L"-brackets, and/or plate spacers, depending on the location and the type of door and frame. Use the diagram below to help decide whether or not an optional bracket will be necessary for installation.

See page 7 for a complete list of SECO-LARM accessories.

Typical Installation

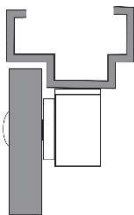
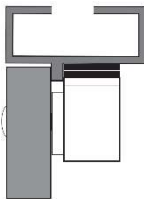
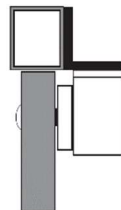

Plate Spacers



"L" Bracket



"L"-Bracket and "Z"-Bracket

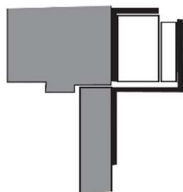

**"U" Bracket
(Typically for glass doors)**

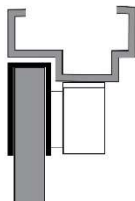

Armature-Mounting Plate

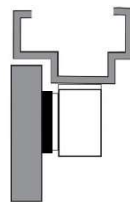

Installation Notes:

1. Read this installation manual thoroughly. A clear understanding of the product and this manual will make installation much easier.
2. The electromagnetic lock is designed for indoor use ONLY.
3. The most suitable mounting location for the electromagnetic lock may require the use of additional SECO-LARM accessories such as Z-brackets, L-brackets, and/or spacer plates. Please see the diagram on page 3 to decide if a particular application requires any mounting accessories. See page 7 for a complete list of SECO-LARM accessories.
4. Do not run power wires and signal wires in the same conduit as this may cause interference.
5. Do not install a diode in parallel with the electromagnetic lock as this may cause a delay when releasing the door as well as cause residual magnetism.
6. The best location to install the electromagnetic lock is on the inside of the door that is being secured with the wiring concealed in the frame to prevent tampering with the unit.

Installation:

1. Fold the mounting template along the dotted line to form a 90-degree angle.

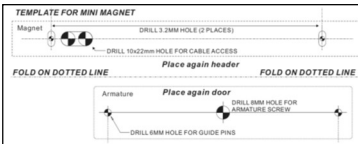
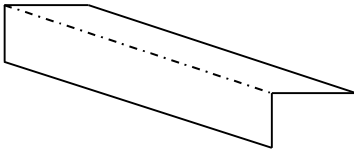

2. Close the door. Find a mounting location on the door frame near the upper free-moving corner of the door, or as close as possible to the upper corner of the door frame opposite the hinges.

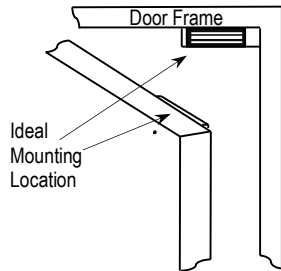

3. Place the template against the door and frame. Mark where the holes are to be drilled.

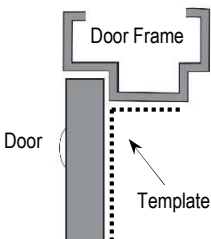

4. Drill two holes in the frame and three holes in the door as shown on the template.

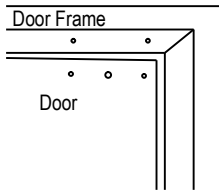

5. Use a hammer to lightly tap the guide pins into the guide pin holes on the armature plate.

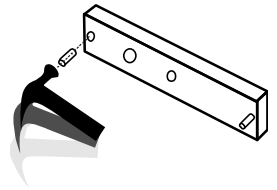

6. Depending on the type of door being protected, drill holes according to the diagrams below:

Hollow Metal Door

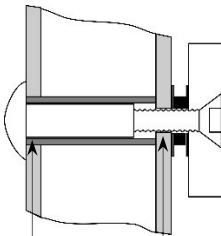

5/8" (16mm) 5/16" (8mm)

Reinforced Door

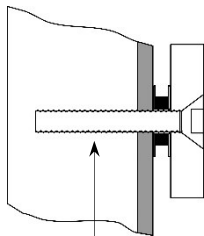

1/4" (6.8mm) for M8x1.25 thread

Solid Core Door

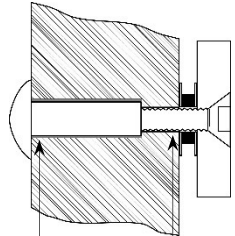

1/2" (12.7mm) 5/16" (8mm)

Drill a 5/16" (8mm) dia. hole through the armature-plate side of the door for the armature screw. Then drill a 5/8" (16mm) dia. hole for sexnut screw on the opposite side of the door.

Drill a 1/4" (6.8mm) dia. and 1" (25mm) deep hole, tap for M8x1.25 thread.

Drill an 5/16" (8mm) dia. hole on the door for the armature screw, and drill a 1/2" (12.7mm) dia. and 1" (25mm) deep hole for the sexnut screw.

7. Put a rubber washer between the two metal washers, and place them over the armature screw between the armature plate and the door. This allows the plate to pivot around the screw to compensate for door misalignment.

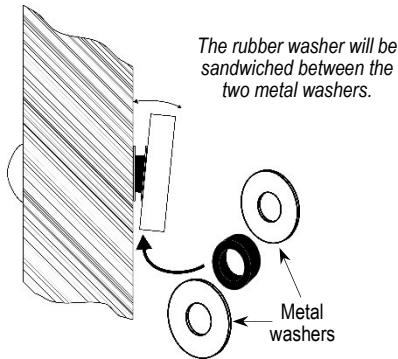

8. Tighten the armature screw enough so that the armature plate can withstand a break-in attempt, but loose enough so that the armature plate can pivot slightly. Make sure the anti-spin guide pins are in the two guide pin holes.

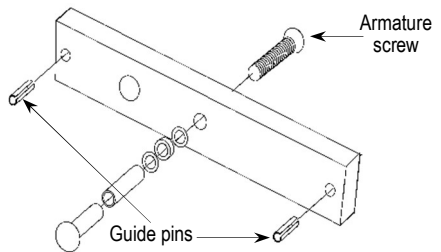

Tip: Use a thread-locking compound on the armature screw to ensure a long-lasting installation.

9. Screw the two short self-tapping screws through the mounting plate's slotted holes, but do not over-tighten them. Keeping them loose will allow for adjustment of the plate left or right so that the mounting plate and the armature plate form a 90-degree angle. See the diagram below.

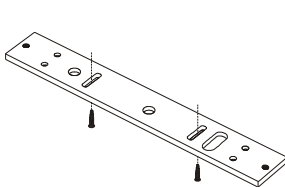

300-lb and 600-lb mounting plate

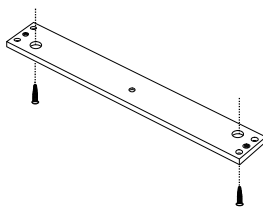

300-lb mounting plate

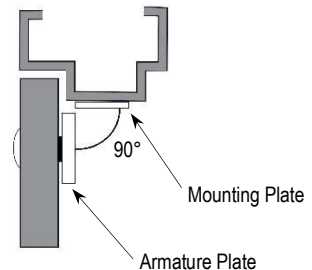

90°
Mounting Plate

Armature Plate

SECO-LARM Electromagnetic Locks

10. Once the position of the mounting plate is correct, use the four long self-tapping screws to permanently mount the mounting plate.

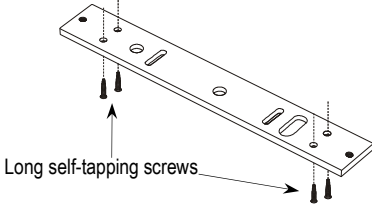

11. Drill the cable access hole. Run the power leads through the cable access hole in the mounting plate and through the hole in the door frame.

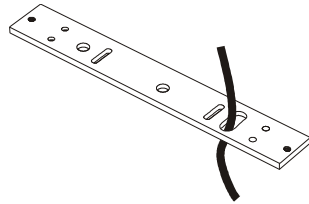

12. Remove the cover from the front of the electromagnet. Run the power leads through the large cable access hole.

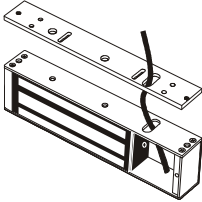

Skip this step for E-941SA-300. Power leads are pre-installed. Faceplate does not detach.

13. Push the electromagnet against the mounting plate so the electromagnet ends are flush with the ends of the mounting plate. Use the Allen wrench to screw the hex-head mounting screws through the bottom of the electromagnet into the mounting bracket.

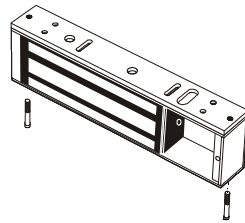

14. Cut the wires so they are long enough to connect with the terminal block. Set the voltage using the selection jumpers based on your input voltage.

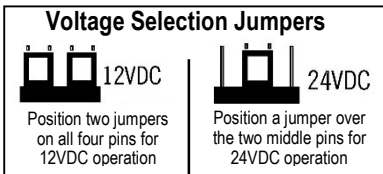

NOTE: Failure to correctly set the input voltage may cause damage to the lock.

NOTE: Connect switching devices like push-to-exit switches between the power source and the positive terminal on the lock. Connecting switching devices to the negative terminal may cause a delay in unlocking.

15. Connect the power wires according to the wiring diagram on page 7. Test the unit. Then replace the front cover and install the hex-head tamper caps.

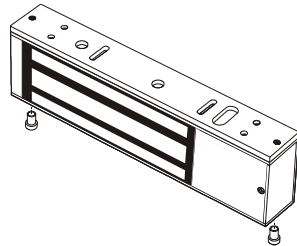

NOTE: This should be the very last step, as once the tamper caps are in place they are very difficult to remove.

Wiring Diagram:

Bond Status Sensor:

The Bond Status Sensor checks to make sure the door is closed, and the electromagnet is locked.

LED Indicators:

Green	Door is closed and locked
Red	Door not closed and/or locked
Off	Door in use / No power

600PQ and 1K2P models ONLY

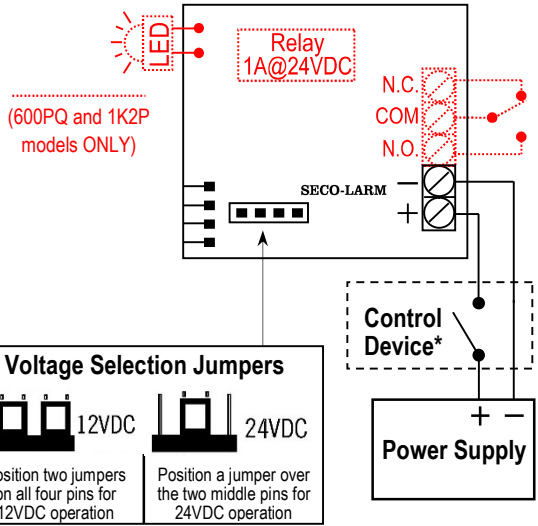

***NOTE:** Connect switching devices like push-to-exit switches between the power source and the positive terminal on the lock. Connecting switching devices to the negative terminal may cause a delay in unlocking.

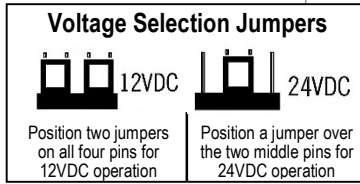

Maximum Distance from Power Source to Electromagnetic Lock:

For a complete chart, please visit www.seco-larm.com

12VDC Minimum Wire Gauge:





Wire Length	25ft.	50ft.	75ft.	100ft.	150ft.	200ft.	250ft.	300ft.	400ft.	500ft.	1000ft.
Wire Gauge @ 500mA	20	18	18	18	16	14	14	12	10	--	--

24VDC Minimum Wire Gauge:

Wire Length	25ft.	50ft.	75ft.	100ft.	150ft.	200ft.	250ft.	300ft.	400ft.	500ft.	1000ft.
Wire Gauge @ 250mA	24	24	22	20	18	18	16	16	14	14	14

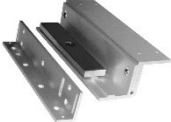
Note: E-941SA-300 is pre-wired.

Optional SECO-LARM Electromagnetic Lock Accessories:

					
Description	"Z" Brackets (includes 1 "L" Bracket)	"L" Brackets	Plate Spacers	Glass Door "U" Brackets	Armature Plate Holders
600-lb. Models	E-941S-600/ZQ	E-941S-600/LQ	E-941S-600/PQ	E-941S-600/UQ	E-941S-600/HQ
1200-lb. Models	E-941S-1K2/ZQ	E-941S-1K2/LQ	E-941S-1K2/PQ	E-941S-1K2/UQ	E-941S-1K2/HQ

Note: Brackets and spacers are not available for E-941SA-300.

SECO-LARM Electromagnetic Locks

Troubleshooting:

Door does not lock Bond status LED does not illuminate	<ul style="list-style-type: none">• Check to make sure the wires are securely tightened to the terminal block.• Check that the power supply is connected and operating.• Use a meter to check the resistance of coils inside the lock. See below.• Make sure the rubber washer is installed and free from damage.
Door locks, but can easily be forced open	<ul style="list-style-type: none">• Make sure the electromagnet and armature plate are properly aligned.• Make sure the contact surfaces of the electromagnet and armature plate are clean and free from rust.• Check the power leads with a meter, and make sure 12VDC or 24VDC is present.• Use a meter to check the resistance of coils inside the lock. See below.• Make sure the rubber washer is installed and free from damage.
Delay in door releasing	<ul style="list-style-type: none">• The electromagnet is fitted with a metal oxide varistor to prevent interference, so do not install a second diode.
No relay output	<ul style="list-style-type: none">• Check that the power is connected properly and turned on.• Make sure the lock is aligned properly.• Make sure the NO/NC/COM are wired properly.

If the Electromagnet has low or no holding force, check the resistance of the coils by performing the following steps:

1. Remove the faceplate from the lock.
2. Disconnect the wire harness from the circuit board.
3. Using a meter, measure the resistance across:
Red / Green wires, and the Black / White wires.
4. Each coil should test $48\Omega \pm 10\%$.
5. If one or both of coils shows an open, short, or incorrect resistance, replace the electromagnet.

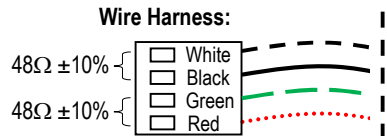

LIFETIME LIMITED WARRANTY This SECO-LARM product is warranted against defects in material and workmanship while used in normal service for the lifetime of the product. SECO-LARM's obligation is limited to the repair or replacement of any defective part if the unit is returned, transportation prepaid, to SECO-LARM. Under no circumstances will SECO-LARM be responsible for any costs or charges for removal, installation, or reinstallation. This Warranty is void if damage is caused by or attributed to acts of God, physical or electrical misuse or abuse, neglect, repair, or alteration, improper or abnormal usage, or faulty installation, or if for any other reason SECO-LARM determines that such equipment is not operating properly as a result of causes other than defects in material and workmanship. The sole obligation of SECO-LARM, and the purchaser's exclusive remedy, shall be limited to repair or replacement only, at SECO-LARM's option. In no event shall SECO-LARM be liable for any special, collateral, incidental, or consequential personal or property damages of any kind to the purchaser or anyone else. This lifetime limited warranty is for products sold and installed in the United States and Canada. For all other countries the warranty is 1 (one) year.

NOTICE: The information and specifications printed in this manual are current at the time of publication. However, the SECO-LARM policy is one of continual development and improvement. For this reason, SECO-LARM reserves the right to change specifications without notice. SECO-LARM is also not responsible for misprints or typographical errors. Copyright © 2020 SECO-LARM U.S.A., Inc. All rights reserved. This material may not be reproduced or copied, in whole or in part, without the written permission of SECO-LARM.

SECO-LARM® U.S.A., Inc.

16842 Millikan Avenue, Irvine, CA 92606

Tel: 800-662-0800 / 949-261-2999 Fax: 949-261-7326

Website: www.seco-larm.com

E-mail: sales@seco-larm.com

 PITGW1

MI_E-941SA-xxxx_200724.docx