

ENFORCER®

Relay Modules Installation Manual

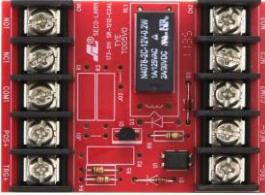

SR-1212-C2ALQ



SR-2206-C5AQ

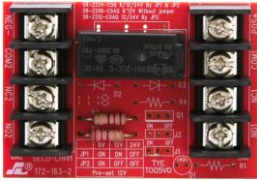

SR-2212-C5AQ



SR-1212-C7ALQ

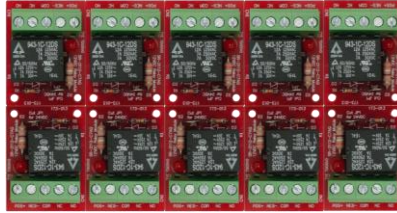

SR-2112-C7AQ/10
(Sold as a breakaway 10-pack)

Model No.	Heavy-Duty	Low-Current	High-Sensitivity	Supply Voltage	Trigger Voltage	Relay Rating	No. of Relays
SR-1212-C2ALQ		X	X	12/24 VDC	3~24 VDC	2A	1 (DPDT)
SR-2206-C5AQ	X			6/12 VDC	6/12 VDC	5A	1 (DPDT)
SR-2212-C5AQ	X			12/24 VDC	12/24 VDC	5A	1 (DPDT)
SR-1212-C7ALQ	X		X	12/24 VDC	3~24 VDC	7A	2 (SPDT)
SR-2112-C7AQ/10*	X			12/24 VDC	12/24 VDC	7A	1 (SPDT)

*Breakaway 10 pack

SECO-LARM® SLI™



Note: Products with model numbers that end with "Q" or that have a round green "Q" sticker are RoHS compliant.

Specifications:

	SR-1212-C2ALQ	SR-2206-C5AQ	SR-2212-C5AQ	SR-2112-C7AQ/10	SR-1212-C7ALQ
Supply voltage	12/24 VDC	6/12 VDC	12/24 VDC	12/24 VDC	12/24 VDC
Trigger voltage	3-24 VDC	6/12 VDC	12/24 VDC	12/24 VDC	3-24 VDC
Voltage selection	Auto-sensing	Auto-sensing	Jumper	Jumper	Jumper
Relay type	DPDT	DPDT	DPDT	SPDT	SPDT
Relay rating	2A	5A	5A	7A	7A
Number of relays	1	1	1	1	2
Current draw	15mA@12VDC 18mA@24VDC	70mA@6VDC 80mA@12VDC	70mA@ 12/24 VDC	35mA@12VDC 40mA@24VDC	60mA@ 12/24 VDC
Size	2 ³ / ₄ "x1 ¹⁵ / ₁₆ "x3 ¹ / ₄ " (70x50x20 mm)	2 ³ / ₄ "x1 ⁷ / ₈ "x3 ¹ / ₄ " (70x48x20 mm)		1 ⁹ / ₁₆ "x1 ³ / ₁₆ "x3 ¹ / ₄ " (40x30x20 mm)	2 ³ / ₈ "x1 ⁹ / ₁₆ "x3 ¹ / ₄ " (60x40x20mm)
Weight	1.6-oz (45g)	2-oz (55g)		0.7-oz (20g)	1.3-oz (37g)

Overview:

SR-1212-C2ALQ

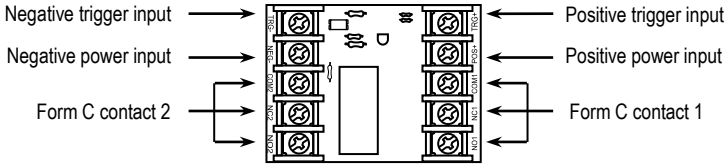

SR-2206-C5AQ

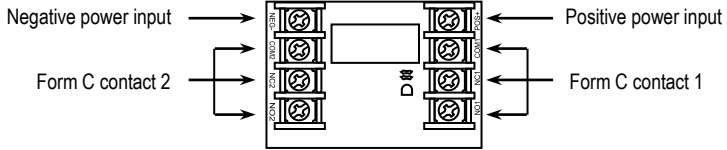

SR-2212-C5AQ

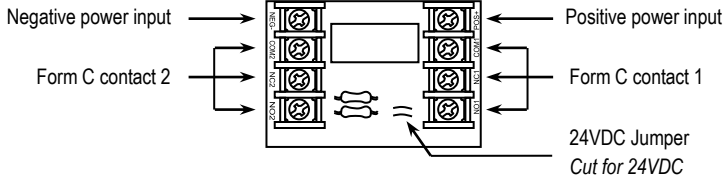

SR-2112-C7AQ/10

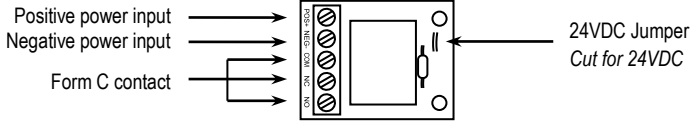

SR-1212-C7ALQ

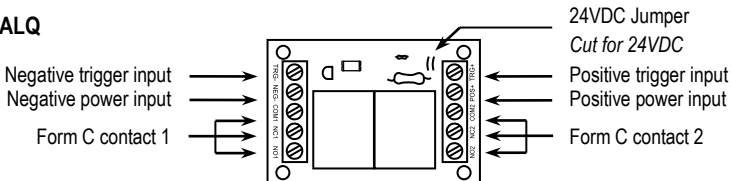

Sample Applications: (Double sided foam tape included)

Two Dry Relay Outputs

Use this application to trigger devices when an alarm activates.

SR-2206-C5AQ, SR-2212-C5AQ,
and SR-2112-C7AQ/10*

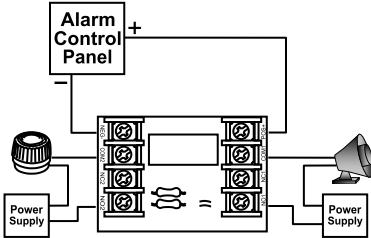

*SR-2112-C7AQ can only trigger one device.

SR-1212-C2ALQ
and SR-1212-C7ALQ

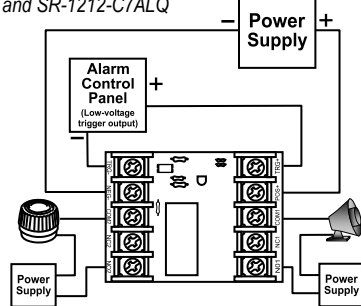

Dual Switch

Use this application to trigger a 12VDC device (such as a siren) and a 120VAC device (such as a floodlight).

SR-2206-C5AQ
and SR-2212-C5AQ

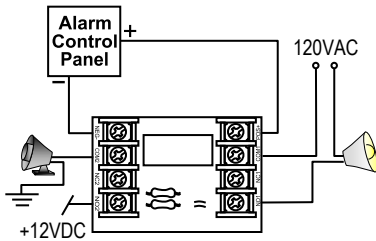

SR-1212-C2ALQ
and SR-1212-C7ALQ

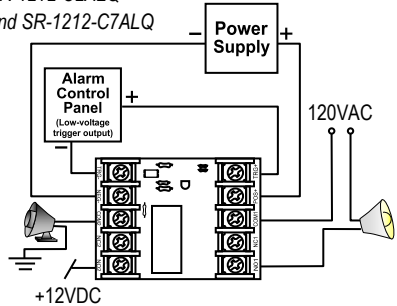

Latching

This will trigger an alarm or silent alarm while disabling the electromagnetic door locks to allow egress.

SR-2206-C5AQ
and SR-2212-C5AQ

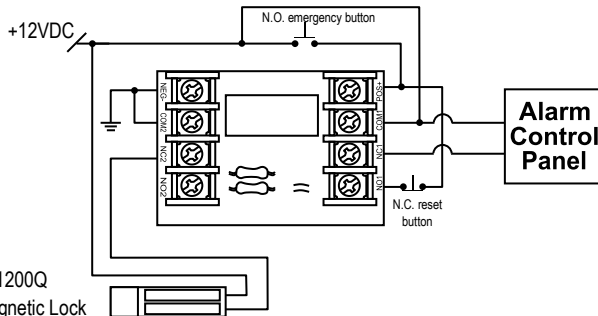

E-941SA-1200Q
Electromagnetic Lock

Also Available from SECO-LARM:

ENFORCER Power Supply Chargers

- Convert low-voltage AC input power to low-voltage DC output power
- Regulated and filtered output voltage
- Short-circuit protection
- Thermal protection and compensation
- Built-in backup battery charger
- Two LEDs to indicate AC power input and DC power output status
- Reverse polarity protected



(ST-2406-3AQ pictured)

Model #	DC Voltage	Current (continuous)	Current (peak)
ST-1206-1.5AQ	6/12	1.5A	2A
ST-2406-2AQ	6/12/24	1.5A	2A
ST-2406-3AQ	6/12/24	2.5A	3A
ST-2406-5AQ	6/12/24	4A	5A
ST-2406-7AQ	6/12/24	7A	7.5A
ST-2406-10AQ	6/12/24	9A	10A

ENFORCER Timer Modules



SA-025Q

Timer Module

- Adjustable timer (1 second~60 minutes)
- Form C relay output
- 12/24 VDC



SA-026Q

Mini Timer Module

- Adjustable timer (1~180 seconds)
- NO/NC switch trigger
- 12~24 VAC/VDC
- Built-in beeper

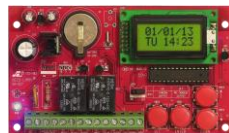

SA-027Q

365-Day Annual Timer

- 2 Form C relay outputs
- 100 Programmable events
- Block programming
- Built-in LCD display

WARRANTY: This SECO-LARM product is warranted against defects in material and workmanship while used in normal service for a period of one (1) year from the date of sale to the original customer. SECO-LARM's obligation is limited to the repair or replacement of any defective part if the unit is returned, transportation prepaid, to SECO-LARM.

This Warranty is void if damage is caused by or attributed to acts of God, physical or electrical misuse or abuse, neglect, repair or alteration, improper or abnormal usage, or faulty installation, or if for any other reason SECO-LARM determines that such equipment is not operating properly as a result of causes other than defects in material and workmanship.

The sole obligation of SECO-LARM and the purchaser's exclusive remedy, shall be limited to replacement or repair only, at SECO-LARM's option. In no event shall SECO-LARM be liable for any special, collateral, incidental, or consequential personal or property damages of any kind to the purchaser or anyone else.

NOTICE

The information and specifications printed in this manual are current at the time of publication. However, the SECO-LARM policy is one of continual development and improvement. For this reason, SECO-LARM reserves the right to change specifications without notice. SECO-LARM is also not responsible for misprints or typographical errors.

Copyright © 2013 SECO-LARM U.S.A., Inc. All rights reserved. This material may not be reproduced or copied, in whole or in part, without the written permission of SECO-LARM.

SECO-LARM® U.S.A., Inc.

16842 Millikan Avenue, Irvine, CA 92606

Tel: 800-662-0800 / 949-261-2999

Website: www.seco-larm.com

E-mail: sales@seco-larm.com

 PITSW1

MISR-xxxx-CkAQ_1309.docx

Order Part# 763-144-8%