

ENFORCER®

Curtain Sensors Manual

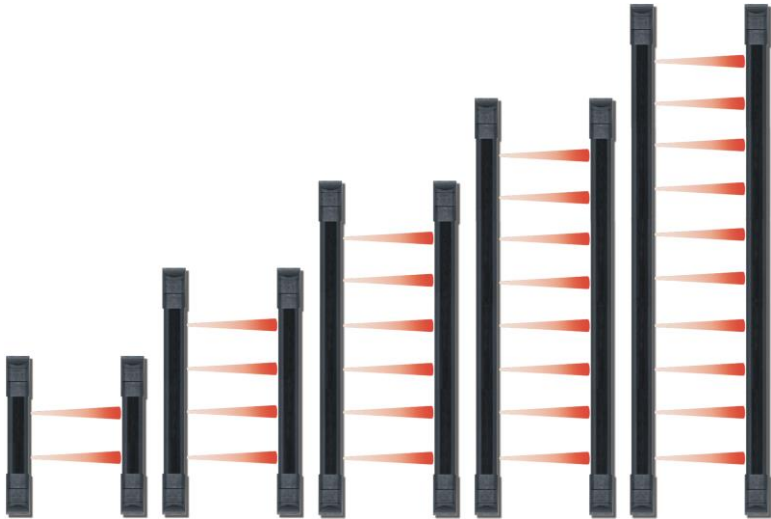

Model	Number of Beams	Length	Color
E-9680-10B25	10	80"	Black
E-9660-8B25	8	60"	Black
E-9644-6B25	6	44"	Black
E-9644-6W25	6	44"	White
E-9622-4B25	4	22"	Black
E-9622-4W25	4	22"	White
E-9611-2B25	2	11"	Black
E-9611-2W25	2	11"	White

ENFORCER Curtain Sensors

Table of Contents:

Features	2	Running the Wires	5
Parts List.....	2	Connecting the Wires.....	5-6
Dimensions	2	Removing the Lens Caps.....	6
Specifications	2	Connecting One or More Sensors	7
Sample Installations	3	Mounting the Transmitter and Receiver and Testing the Sensor	7
Choosing a Location	3-4	Tamper Protection	8
Selectable 3-Channel Beam Frequency	4	Troubleshooting	8
Mounting the Curtain Sensor	4-5		

Features:

- Multi-frequency to reduce interference between multiple units
- Install on windows, doorways, skylights, fence tops, and any place where space is limited
- Perfect for indoor and outdoor perimeter security
- Slimline design – 1⁵/₁₆"x7⁷/₈" (33x22 mm)
- Rugged aluminum construction
- NO/NC Relay output
- 2, 4, 6, 8, or 10 separate photoelectric beam sensors; programmable trigger upon breaking of any single beam or simultaneous breaking of any two adjacent beams
- Anti-tamper circuit for use when power is cut or end cap is removed
- No synchronizing wires required
- LED alignment indicator
- L-brackets and mounting hardware included

Parts List:

- 1x Transmitter
- 1x Receiver
- 4x L-Brackets
- 1x Manual
- Mounting hardware

Dimensions:

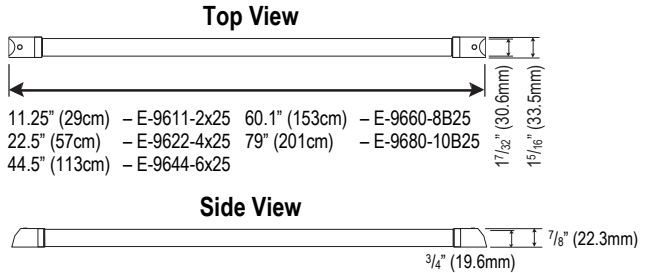

Specifications:

Model	E-9611-2x25	E-9622-4x25	E-9644-6x25	E-9660-8B25	E-9680-10B25
Standby@12-24 VDC	80mA	89mA	94mA	102mA	110mA
Active@12-24 VDC	60mA	73mA	79mA	92mA	100mA
Dimensions	11 ¹ / ₄ "x15 ¹ / ₁₆ "x7 ⁷ / ₈ " (286x33x22 mm)	22 ¹ / ₂ "x15 ¹ / ₁₆ "x7 ⁷ / ₈ " (572x33x22 mm)	44 ¹ / ₂ "x15 ¹ / ₁₆ "x7 ⁷ / ₈ " (1130x33x22 mm)	60 ¹ / ₈ "x15 ¹ / ₁₆ "x7 ⁷ / ₈ " (1527x33x22 mm)	79"x15 ¹ / ₁₆ "x7 ⁷ / ₈ " (2007x33x22 mm)
Response time	0.5-20 ms	0.5-32.5 ms	0.5-48.5 ms	0.5-60 ms	0.5-70 ms
Maximum range	Indoor: 50' (16m), outdoor: 25' (8m)				
Detection method	Simultaneous break of 2 adjacent beams or any single beam (programmable)				
Output	NO/NC Relay output, 1A@12-24 VDC				
Operating temperature	49°~131° F (-45°~55° C)				
Attenuation LED	ON: Powered, aligned properly; Flashing: Beam broken or unaligned; OFF: No power				
Enclosure / Case	IP65 / Aluminum alloy				

Sample Installations:

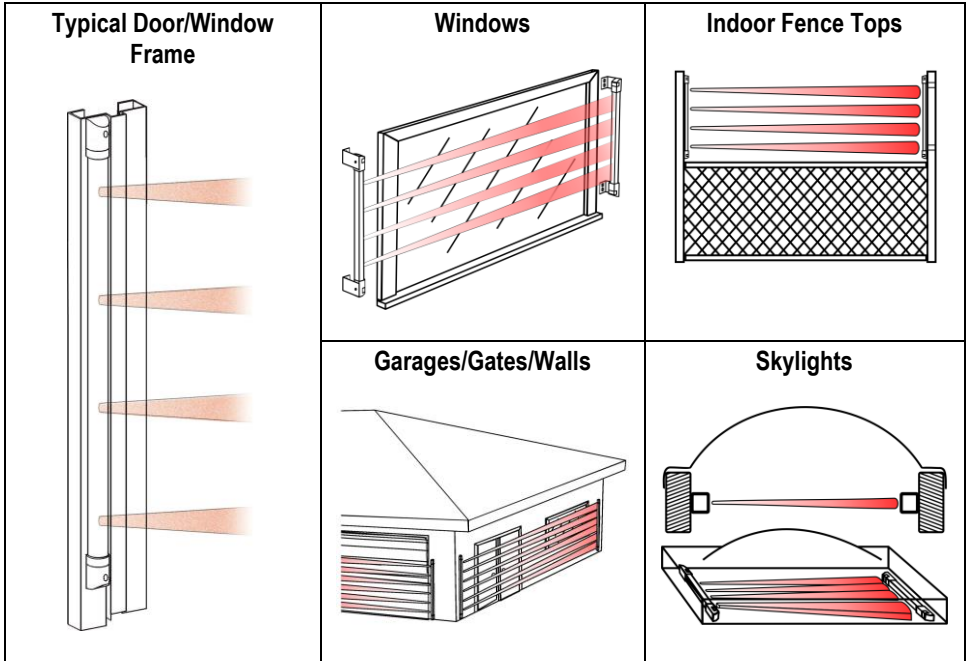

Important:

Do not connect to power until the sensor is completely installed and the installation has been double-checked.

Choosing a Location:

When used outdoors, place the curtain sensor under a roof or shelter. This will reduce the chance of false alarms caused by rain or snow.

To prevent erratic operation and/or false alarms:

- Wind will not directly cause false alarms, but could cause leaves or similar objects to fly into or otherwise obstruct the beams. Do not mount near trees, bushes, or other leafy vegetation (see Fig. 1).
- Do not mount where water running off the roof might break the beam (see Fig. 1). The sensor and beams must be sheltered.
- Do not mount near reflective surfaces, as this could prevent the sensor from working properly.

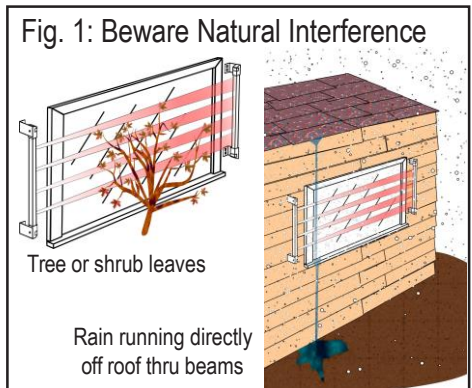

Choosing a Location, continued:

- Do not mount where the transmitter or receiver could be splashed by water or mud.
- Do not mount where unit could be suddenly exposed to a bright light, such as a floodlight or a passing car's headlight.
- Do not let sunlight or any direct beam of light shine directly on the curtain beam sensor. If unavoidable, mount so the transmitter, not the receiver, faces the sun (see Fig. 2).
- Do not mount where animals or other objects could accidentally break the beams.

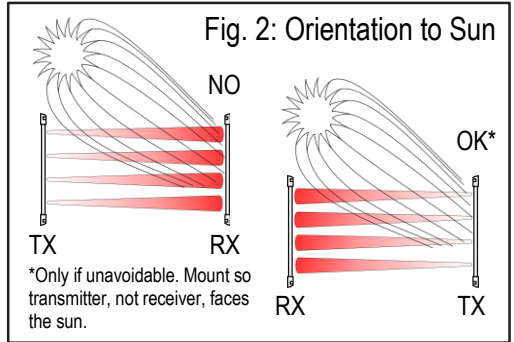

Selectable 3-Channel Beam Frequency:

The sensor beam frequency can be set at different frequencies on-site to avoid interference from multiple curtain sensors nearby. To select between three different beam frequencies, set the jumper of the transmitter side and receiver side (see Fig. 3).

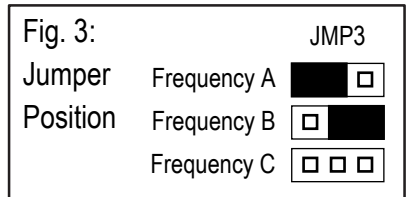

Note:

1. If the frequency is changed, power must be cycled on the transmitter and receiver after the new frequency is selected.
2. Both the transmitter and the receiver of each pair must be set to matching frequencies to work together correctly.

Mounting the Curtain Sensor:

1. Find a suitable location (see Fig. 1):
 - a. The transmitter and receiver can be mounted at any angle as long as they are parallel to each other and directly facing each other, and as long as the wires come out of the same ends of both units (see Fig. 4).
 - b. If using multiple curtain sensors, be sure to set each for a different frequency (see Selectable 3-Channel Beam Frequency above).
 - c. The transmitter and receiver must not be separated by more than 50 feet indoors and 25 feet outdoors.

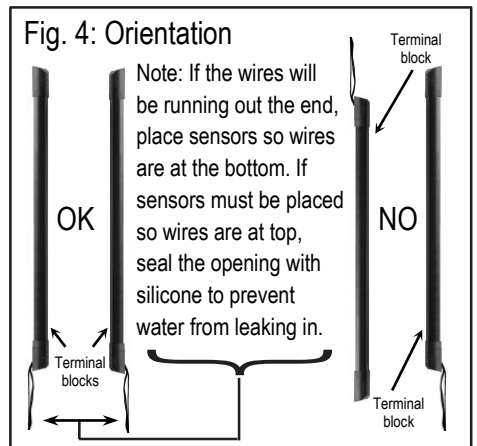

Mounting the Curtain Sensor, continued:

2. Mount the transmitter and the receiver so that the surface-mounted wires do not come out from above the units. This is to prevent water from entering via the wire holes. If this is unavoidable, use silicone to completely cover the area where the wires come out the holes to prevent water from entering (see Fig. 4).
3. Once a suitable mounting location has been found, remove the covers of the end caps (see Fig. 5), and pull the tamper buttons out of the end caps (one per transmitter or receiver) and locate the mounting holes.

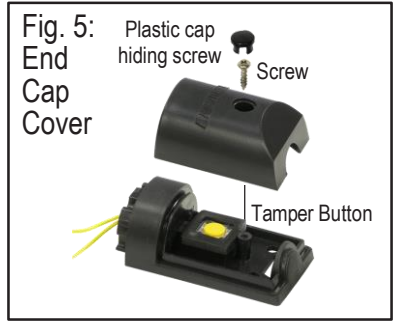

Using these holes as a template, mark their location on the wall with a pencil.

4. Connect the wires (see Figs. 6 and 7) before permanently mounting the units to the wall.

Running the Wires:

Run four wires (2x power and 2x alarm signal) from the alarm control panel to the receiver of the curtain sensor. Shielded cable is strongly suggested. See Table 1 to the right for maximum wire length. Two power wires must also be run to the transmitter.

Voltage	Gauge	Max. length
12VDC	AWG 22	1800' (550m)
12VDC	AWG 20	2600' (800m)
24VDC	AWG 22	2600' (800m)
24VDC	AWG 20	3900' (1200m)

It may be more convenient to connect the transmitter's two power wires to the receiver's power wires. In this case, run six wires to the receiver: two wires to the power source, two for the alarm signal, and two to the transmitter.

Note:

1. If burying the wires is required, make sure to run them through electrical conduit. Shielded cable is strongly suggested.
2. If the wires are run along the wall, using an armored cable is strongly suggested.

Connecting the Wires:

1. Receiver:

- a. Pull the end cap with the red wire leads off the receiver, and slide the PCB out far enough to expose the wiring block.
- b. Run the four wires (or six wires, if connecting the transmitter's power wires to the receiver) through one or more of the three ground knockout holes in the end cap near where the tamper button wires run, and connect them to the wiring block (see Fig. 6).
- c. Program the receiver (see Table 2 on pg. 6).
- d. Carefully push the PCB back into the case and reinsert the end cap.
- e. Reinsert the cap over the tamper button and small tamper cap.

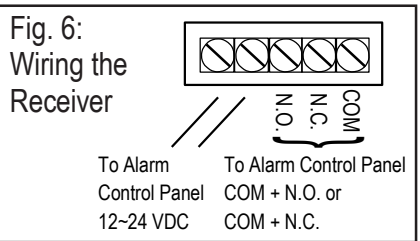

Connecting the Wires, continued:









2. Transmitter:

- a. Pull the end cap with the red wire leads off the transmitter, and slide the PCB out far enough to expose the wiring block.
- b. Run the two power wires through one or more of the three round knockout holes in the end cap near where the tamper button wires run; connect them to the wiring block (see Fig. 7).
- c. Program the transmitter (see Table 2 below).
- d. Carefully push the PCB back into the case and reinsert the end cap.
- e. Reinsert the cap over the tamper button and small tamper cap.

Note:

1. Screw the wires tightly to avoid slipping off the terminals, but not so tight that they break.
2. Unused terminal screws should be tightened.
3. Grounding may be necessary, depending on the location.

Table 2: Transmitter and Receiver Programming

	Receiver		Transmitter	
Jumper name	JMP1		JMP0	
LED Operation	<p>1 C 2</p>  <ul style="list-style-type: none"> • LED ON if power is present and beams are aligned. • LED flashes when beams are broken. 	<p>1 C 2</p>  <ul style="list-style-type: none"> • LED OFF if power is present and beams are aligned. • LED flashes when beams are broken. 	<p>LED ON</p>  <ul style="list-style-type: none"> • LED ON if power is present. 	<p>LED OFF</p>  <ul style="list-style-type: none"> • LED OFF at all times.
Jumper name	JMP2		SA1	
Number of beams to interrupt to trigger transmitter and receiver	 1 Beam Receiver triggers if any single beam is interrupted.*	 2 Beams Receiver triggers only if 2 adjacent beams interrupted at same time.*	 1 Beam Transmitter triggers if any single beam is interrupted.*	 2 Beams Transmitter triggers only if 2 adjacent beams interrupted at same time.*

*Both JMP2 and SA1 should be taken off or left on at the same time.

Removing the Lens Caps (for outdoor use only):

For best results when the curtain sensor is mounted outdoors, remove the transmitter lens caps (**DO NOT** remove the receiver lens caps!).

To remove the lens caps (see Fig. 8):

1. Slide the PCB out of the transmitter (see “Connecting the Wires” on pg. 5~6).
2. Carefully pull the lens cap off of all the lenses (4 for the E-9611-2x25, 8 for the E-9622-4x25, 12 for the E-9644-6x25, 16 for the E-9660-8B25, 20 for the E-9680-10B25).
3. Slide the PCB back in (see “Connecting the Wires” on pg. 5~6).

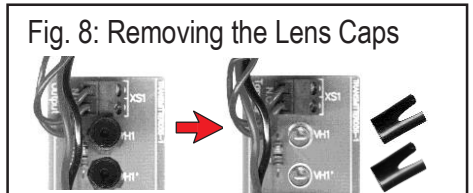

Fig. 8: Removing the Lens Caps

Connecting One or More Sensors:

Several units can be connected together in parallel to the same power supply output and alarm input of an alarm control panel.

Please reference Fig. 6 & 7 for terminal blocks.

Standard

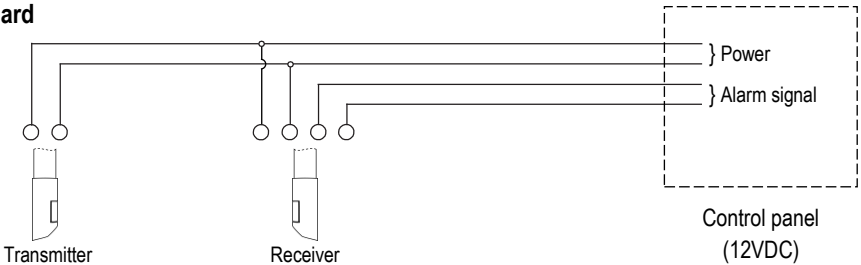

Dual Sensors, Separate Alarm Channels

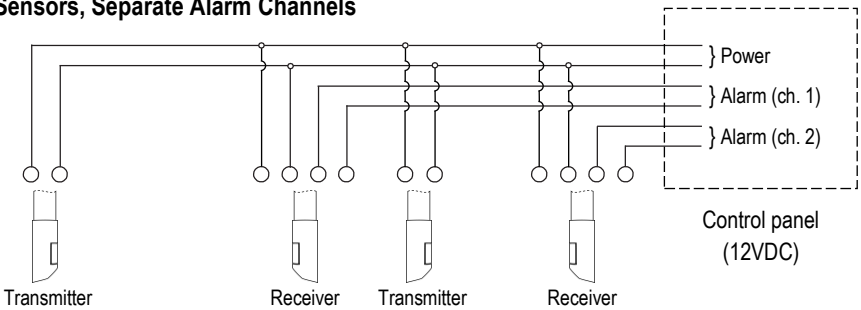

In-line, Single Alarm Channel

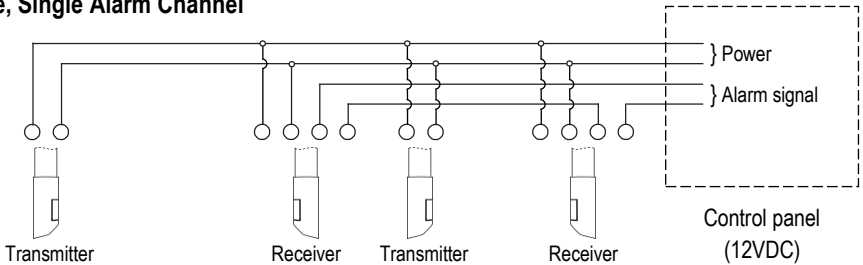

Mounting the Transmitter and Receiver and Testing the Sensor:

1. Temporarily mount the transmitter and receiver to where they are expected to be mounted, so the mounting position can be changed if necessary.
2. Connect the transmitter and the receiver.
3. Once it is powered up, test the curtain sensor by breaking two adjacent beams or any single beam (depending on programming).
4. The curtain sensor also has red LEDs which can be used for testing purposes (see Table 2).
5. After the curtain sensor is tested and aligned, permanently mount it.
6. After it is mounted, test the curtain sensor again.

Tamper Protection:

The receiver and the transmitter both have a tamper switch on one end to protect against someone attempting to open the unit. However, there is no separate tamper output to the alarm control panel. Instead, the alarm output is triggered if the cover of the end cap with the tamper button is removed, if the transmitter or receiver is moved out of alignment, or if power is disconnected.

Troubleshooting:

Transmitter LED will not turn ON	<ul style="list-style-type: none">• Test the power and ground wire with a voltage meter to ensure power is connected and is of the correct voltage.• Change the position of the transmitter jumper “JMP0” (see page 6).
Receiver LED will not turn ON	<ul style="list-style-type: none">• Test the power and ground wire with a voltage meter to ensure power is connected and is of the correct voltage.
Receiver LED will not turn ON unless the sensor is triggered	<ul style="list-style-type: none">• Change the position of the receiver jumper “JMP1” (see page 6).
Receiver LED flashes continuously	<ul style="list-style-type: none">• Check that the transmitter and receiver are aligned.
Does not trigger when beam is broken	<ul style="list-style-type: none">• Remount the curtain sensor away from any shiny surface, or repaint the surface to cut down on reflection.
Receiver continuously triggers the alarm	<ul style="list-style-type: none">• Check that the transmitter and receiver are aligned.• Check that the tamper button and the cover for the tamper button are mounted correctly.
False alarm	<ul style="list-style-type: none">• Re-install so that multiple sensors do not interfere with each other.• Cut back leafy vegetation.• Re-mount away from the edge of a roof.• Mount under a roof or shelter.

LIMITED WARRANTY: This SECO-LARM product is warranted against defects in material and workmanship while used in normal service for one (1) year from the date of sale to the original customer. SECO-LARM's obligation is limited to the repair or replacement of any defective part if the unit is returned, transportation prepaid, to SECO-LARM. This Warranty is void if damage is caused by or attributed to acts of God, physical or electrical misuse or abuse, neglect, repair or alteration, improper or abnormal usage, or faulty installation, or if for any other reason SECO-LARM determines that such equipment is not operating properly as a result of causes other than defects in material and workmanship. The sole obligation of SECO-LARM and the purchaser's exclusive remedy, shall be limited to the replacement or repair only, at SECO-LARM's option. In no event shall SECO-LARM be liable for any special, collateral, incidental, or consequential personal or property damage of any kind to the purchaser or anyone else.

NOTICE: The information and specifications printed in this manual are current at the time of publication. However, the SECO-LARM policy is one of continual development and improvement. For this reason, SECO-LARM reserves the right to change specifications without notice. SECO-LARM is also not responsible for misprints or typographical errors. Trademarks are the property of SECO-LARM U.S.A., Inc. or their respective owners.

Copyright © 2014 SECO-LARM U.S.A., Inc. All rights reserved. This material may not be reproduced or copied, in whole or in part, without the written permission of SECO-LARM.

SECO-LARM® U.S.A., Inc.

16842 Millikan Avenue, Irvine, CA 92606

Website: www.seco-larm.com

 PICTN1

Phone: (949) 261-2999 | (800) 662-0800

Email: sales@seco-larm.com

MIE-96xx-xxB25_141008.docx