

ENFORCER®

PR-312S-PQ

Indoor Proximity Card Reader

Manual



- Stand-alone operation
- Status LEDs for operations and programming
- Solid-state lock relay for longer life, lower power consumption, and shock/vibration resistance
- Up to 500 user cards
- Up to 5 super user cards, plus 1 master card
- 10 Cards included (additional cards available – sold separately in packs of 10)
- Integrated doorbell button

ENFORCER Indoor Proximity Card Reader

Table of Contents:

Introduction.....	2	Basic Programming	8
Specifications	2	Operating the Proximity Card Reader	9
Parts List	2	Advanced Programming	10-14
Dimensions and Overview.....	3	Prog. User Cards	10
Installation	3	Deleting User Cards	11
Mounting Diagram	3	Deleting a Lost User Card	11
Wiring the Proximity Card Reader	4	Deleting an Entire User Group.....	12
Wiring Diagram.....	5	Prog. the Door Unlock Mode	12-13
Types of Proximity Cards	6	Prog. System Lockout.....	13
The Master Card	7	Prog./Deleting Super User Cards	14-15
Programming the Master Card	7	Troubleshooting	15
LED Indicators	7	FCC Statement / Warranty	16

Introduction:

The ENFORCER Indoor Proximity Card Reader is a flexible solution for securing controlled access. Its stylish case and small size make it ideal for use in most residential, commercial, and industrial sites. Simple enough to deploy in small businesses, it also has the programming capability to meet the needs of midsize and enterprise companies. Simple installation, high reliability, attractive design, and scalability are all combined in the ENFORCER Proximity Card Reader.

Specifications:

Power input		12VDC
Current draw	Standby	60mA
	Active	80mA
Max. read distance		4" (10cm)
User card limit		500 Cards (5 groups @ 100 users)
Super user card limit		5 cards
Master card limit		1 card
Transmit frequency		125kHz
Outputs	Lock strike relay	Fail-safe/fail-secure, 3A@16VDC (solid-state relay)
	Doorbell relay	N.O. Dry contact, 1A@24VDC
	Tamper switch	N.C. Dry contact, 50mA@16VDC
Relay time delay		Timed output 1~60 or toggle mode
Temperature		-4°~158° F (-20°~70° C)
Relative humidity		5~95%, non-condensing
IP Rating		IP55
Dimensions		4 ³ / ₄ "x2 ³ / ₈ "x1 ⁵ / ₁₆ " (120x60x23 mm)

Parts List:

- 1x Proximity card reader
- 10x Proximity cards
- 1x Manual
- 2x Mounting screws
- 1x Diode

Also Available:

PR-K1S1-A: Proximity cards sold in packs of 10



PR-K1K1-AQ: Proximity key fobs sold in packs of 10



Dimensions and Overview:

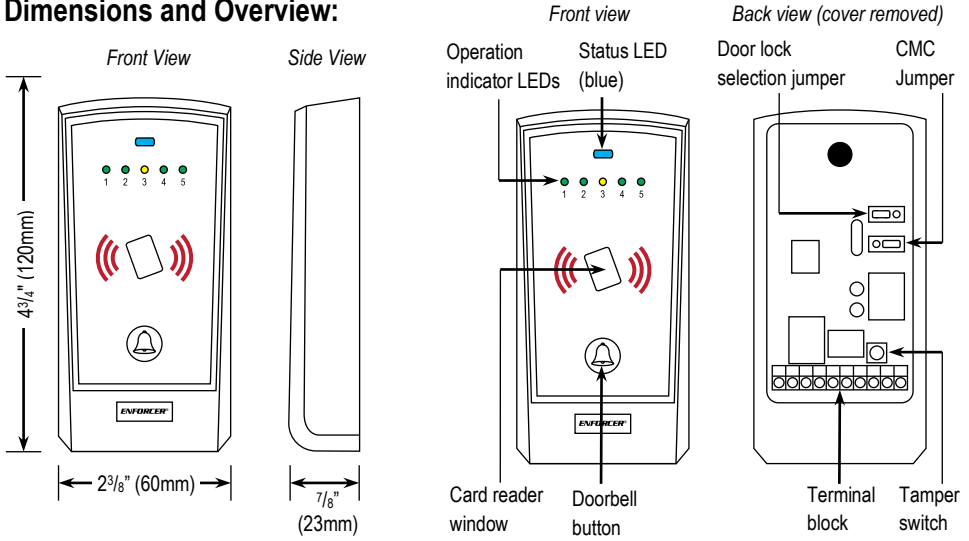

Installation:

1. Unpack the unit and familiarize yourself with the proximity card reader.
2. Test the mounting location of the proximity card reader for fit.
3. Using a Philips screwdriver, remove the screw from the bottom of the proximity card reader and separate the outside case from the base.
4. Place the base on the mounting location and then mark the locations of the two mounting holes and two wire holes.
5. Drill a $\frac{1}{2}"$ hole in the mounting location through which wires can be run to the proximity card reader.
6. Permanently screw the base to the mounting location.
7. Run the wires from the power supply, egress button, door unlocking device, and other accessories as needed through the hole to connect to the terminal block.
8. Connect the appropriate wires to the proximity card reader's terminal block.
9. Reattach the proximity card reader's outside case to the base.
10. The preliminary installation is done. The proximity card reader is ready to power up and program.

Mounting Diagram:

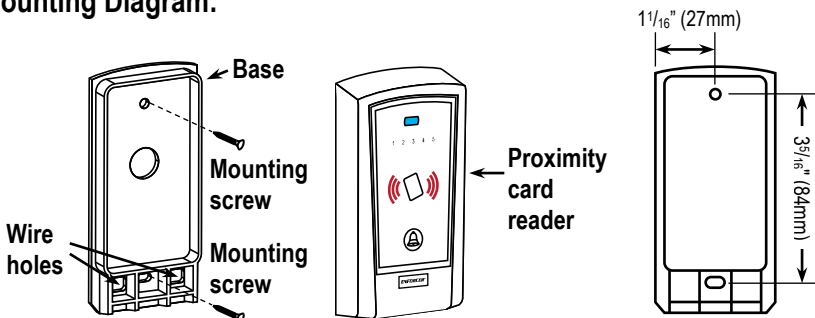

ENFORCER Indoor Proximity Card Reader

Wiring the Proximity Card Reader:

1	2	3	4	5	6	7	8	9	10
(+) 12VDC	(-)	(+) DOOR LOCK	(-)	EG IN	DATA I/O	DOOR BELL N.O.		TAMPER N.C.	

Terminals 1 & 2 – 12VDC Power input:

1. Connect terminal 1 (+) to the positive output of a 12VDC power supply.
2. Connect terminal 2 (-) to the negative output of the power supply. Terminal 2 is also the grounding point of the egress button.

NOTE: The 12VDC power supply must supply enough amperage to also power the door lock/unlock device.

Terminals 3 & 4 – 12VDC Power output for the door lock/unlock device:

1. These terminals provide a max of 3A to power the door lock/unlock device.
2. Connect terminal 3 (+) to the positive input of the 12VDC door lock/unlock device.
3. Connect terminal 4 (-) to the negative input of the 12VDC door lock/unlock device.

NOTE: The door lock/unlock output is programmable for fail-safe or fail-secure operation via the door lock selection jumper. See below to program for fail-safe or fail-secure operation.

- a. Fail-safe electric locks – power ON to lock, OFF to unlock.
- b. Fail-secure electric locks – power OFF to lock, ON to unlock.

Door Lock Selection Jumper:

1. SAFE (For fail-safe operation)

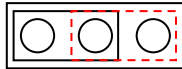

2. SECURE (For fail-secure operation)

Terminal 5 – EG IN (Egress input for a N.O. pushbutton egress button):

1. Mount one or more N.O. pushbuttons inside the protected premises as a way for someone without a proximity card to easily unlock the electronic door lock and leave the room.
2. Connect one terminal of the N.O. pushbutton to terminal 5, and the other to the negative input of the 12VDC power supply (terminal 2).
3. Multiple buttons can be connected in parallel.

Terminal 6 – Data I/O port: Reserved for future use.

Terminals 7 & 8 – Doorbell relay output:

1. Connect to an optional N.O. doorbell or buzzer with a maximum draw of 1A@24VDC.
2. The doorbell sounds for as long as the bell button on the proximity card reader is held.

Terminals 9 & 10 – Tamper switch output:

1. N.C. Output, closed while the proximity card reader is properly attached to its base plate.
2. Connect to the tamper circuit of an optional alarm system.
3. If the proximity card reader is taken off its base, the tamper switch will trigger the alarm system.

Wiring Diagram:

Use the following wiring diagrams to wire the ENFORCER PR-312S-PQ Proximity Card Reader for typical installations:

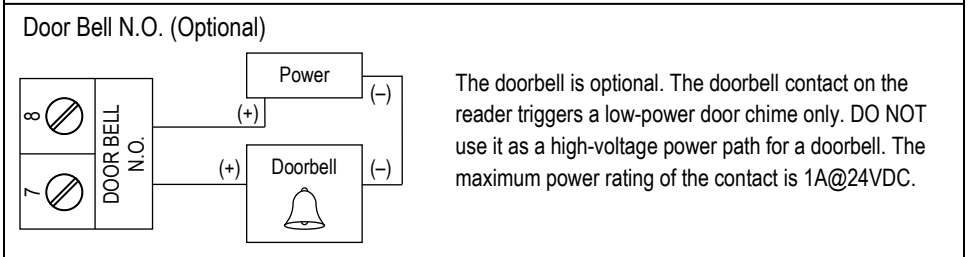
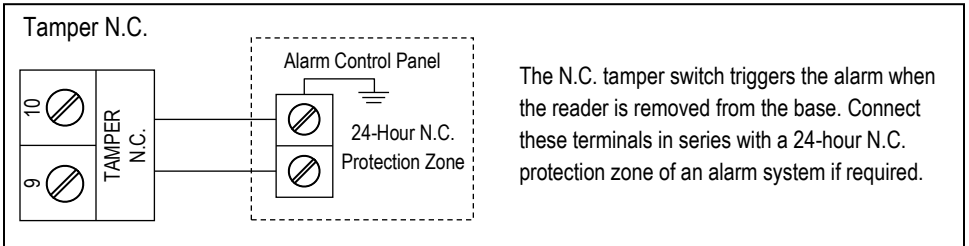
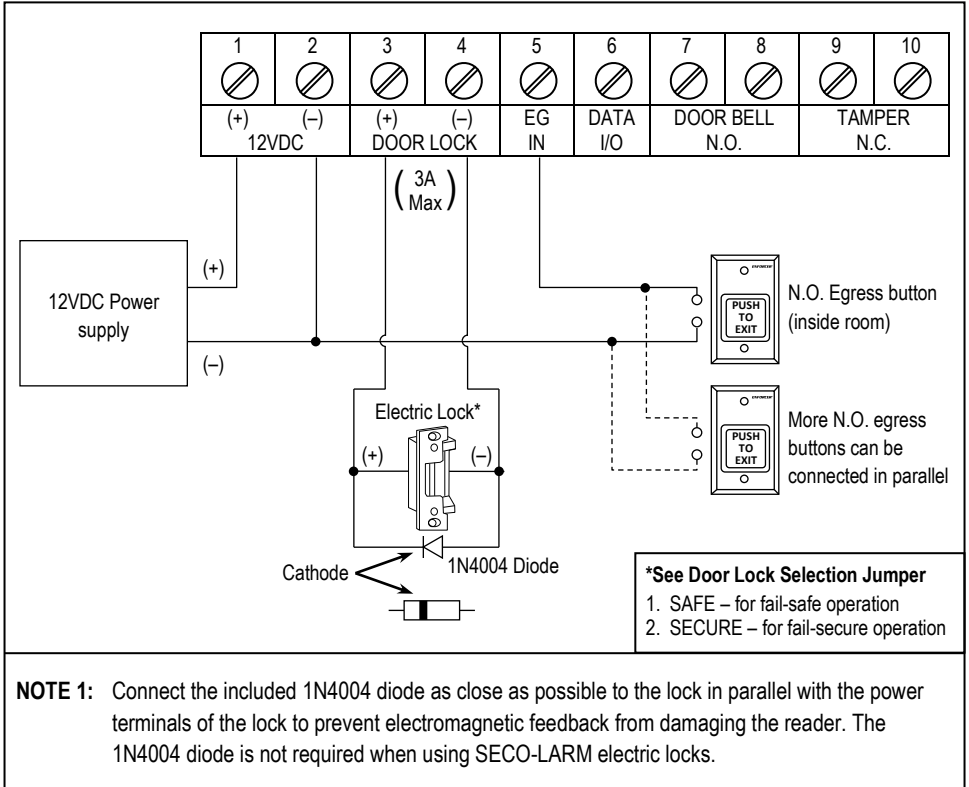

Types of Proximity Cards:

The proximity cards included with the proximity card reader, as well as additional blank proximity cards and keyfobs, can be programmed for use in one of three ways (see pg. 3 for ordering information):

Master Card

- Used to program features of the proximity card reader or to add/delete user and super user cards. The master card will not unlock the door lock device.
- When the PR-312S-PQ Proximity Card Reader is first installed, or if the existing master card is lost, a new master card must first be configured before any programming can be done.
- See page 7 to configure the master card.

User Cards

- Unlocks the door lock device by tapping or swiping the card near the proximity card reader.
- Up to 100 user cards can be programmed per each group of users. There are five user groups, for a maximum of 500 unique user cards.
- Program or delete user cards by using the master card.
- The user groups allow an entire group of user cards to be deleted at once.
- For most simple implementations, it is easiest to put all the users (maximum of 100) into the default user group, group #1.

Super User Cards

- Unlocks the door lock device like a user card, except that the card must be tapped or swiped twice near the proximity card reader.
- Allows trusted executives to disable the proximity card reader to prevent users from unlocking the door with their user cards, and re-enable the proximity card reader to resume normal operation. This function is useful for locking the proximity card reader at night or on the weekend to prevent users from entering the protected premises.
- Up to five super user cards: one for each user group.

“Tapping” vs. “Swiping” the Cards

In the following programming section, the administrator is instructed to “tap” the master or user cards one or more times. Instead of tapping the card on the reader, one could also pass or swipe the card near the reader. However, from a programming point of view, tapping the card ensures the signal was clearly given to the card reader, and makes it easier to count how many times the card was used.

The Master Card:

The master card is necessary to do any programming of the ENFORCER Proximity Card Reader. It will be necessary to configure a master card if:

- The proximity card reader is being installed for the first time, OR
- The most recently configured master card is lost

Only one card can be programmed as the master card. Programming a new master card will automatically delete the old one.

Programming the Master Card:

To program the master card:

Step	Action	Reaction
1	Cut power to the proximity card reader	
2	Move the CMC jumper from OFF to ON (see "Overview" on page 3)	
3	Restore power to the proximity card reader	Reader starts beeping, and blue status LED flashes to signal the start of a 1-minute countdown for configuring the master card
4	Move the CMC jumper from ON to OFF	Reader stops beeping
5	Tap a currently unused proximity card	2 Beeps
6	Press the "Bell" button to save the master card code and exit the master card configuration mode	2 Beeps
7	Label the card as "Master Card" and put in a secure location	

NOTE 1: If the master card is not correctly programmed within the 1-minute countdown period, the blue status LED will turn off. In this case, repeat the above procedure.

NOTE 2: If the master card is lost, program a new master card by repeating the above procedure.

LED Indicators:

1. Status indicator (blue LED) – a steady ON during normal operation, or flashes while the proximity card reader is in the programming mode or in the lock-down mode.
2. Operation indicators (LEDs numbered 1~5) – show the status of the proximity card reader while in the operation mode or in the programming mode.
 - While the proximity card reader is in the operation mode and it reads a programmed card, the LED corresponding to that card's user group turns to a steady ON.
 - While the proximity card reader is in the programming mode, the LEDs show the status of the feature settings (see "Programming" on page 8 for details).

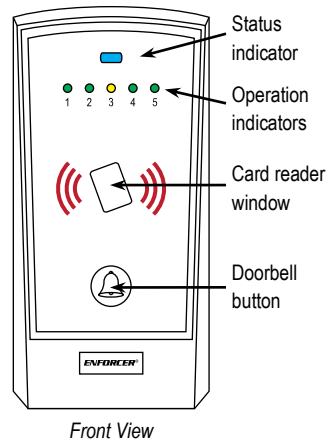

ENFORCER Indoor Proximity Card Reader

Basic Programming:

Most businesses will require basic programming of a super user card and a limited number of user cards. Follow the programming instructions on this page if the owning company fits these requirements:

- Max. 100 user cards
- Max. 1 super user card
- No need to change the default settings of the proximity card reader

NOTE: If more advanced programming is required, see “Advanced Programming” on page 10.

1. Program the master card (see page 7).
2. Program the user cards:

Step	Action	Reaction
1	Tap the master card 1 time	Blue status LED flashes, and LED 1 flashes once
2	Wait 2 seconds	2 Beeps, then LEDs 1 through 5 flash
3	Press the “Bell” button once	LED 1 turns to a steady ON
4	Wait 2 seconds	2 Beeps
5	Tap a blank user card 1 time	2 Beeps
6	For multiple user cards, repeat step 5	2 Beeps for each card confirms that the card was programmed into the reader
7	Exit programming by tapping the master card once	2 Beeps

NOTE: Do not program the same card twice. Once a card has been programmed, attempts to program that card will be rejected with a single long beep of the proximity card reader.

3. Program the super user card:

Step	Action	Reaction
1	Tap the master card 5 times	Blue status LED flashes, and LED 5 flashes once
2	Wait 2 seconds	2 Beeps, then LEDs 1 and 2 flash
3	Press the “Bell” button once	LED 1 flashes once
4	Wait 2 seconds	2 Beeps, then LEDs 1 through 5 flash
5	Press the “Bell” button once	LED 1 turns to a steady ON
6	Wait 2 seconds	2 Beeps
7	Tap a blank user card 1 time	2 Beeps
8	Exit programming by tapping the master card once	2 Beeps

The ENFORCER Indoor Proximity Card Reader is now ready for use.

Operating the Proximity Card Reader:**Unlocking the door with a user card:**

1. Tap the user card once.
2. Two beeps confirm that a valid user card was read. The LED corresponding to the user group (1 through 5) flashes once while the door strike is opened.
3. Five beeps indicate that the user card was not programmed and is invalid.

Unlocking the door with a super user card:

1. Tap the super user card twice within 3 seconds.
2. Two beeps confirm that a valid super user card was read. The LED corresponding to the user group (1 through 5) flashes once while the door strike is opened.
3. Five beeps indicate that the super user card was not programmed and is invalid.

Temporarily disable the proximity card reader with a super user card:

1. Tap the super user card on the reader once, and then press the “Bell” button within 3 seconds.
2. Two beeps confirm that the card reader is disabled. The blue status LED will flash slowly (0.5 sec ON, 1 sec OFF) while the reader is disabled.
3. Five beeps indicate that the super user card was not programmed and is invalid.

NOTE 1: While the card reader is disabled, the blue status LED will flash slowly. The card reader will reject all user cards during this time.

NOTE 2: While the card reader is disabled, the door can be opened using a super user card or by pressing the egress button.

NOTE 3: The doorbell button works as normal whether the card reader is disabled or not.

Re-enable the proximity card reader with a super user card:

1. Tap the super user card on the reader once, and then press the “Bell” button within three seconds.
2. Two beeps confirm that the card reader is now enabled. The card reader returns to normal operation, and the blue status LED flashes turn to a steady ON.
3. Five beeps indicate that the super user card was not programmed and is invalid.

NOTE: Using the master card to program the card reader while it is disabled will automatically re-enable the reader upon exiting the programming mode. This allows the master card user to retain control of the system even if the super user card is lost.

Advanced Programming:

This section includes complete programming information. For a typical installation that does not need full programming, see Basic Programming (page 8).

Adding User Cards:

The ENFORCER Proximity Card Reader can learn up to 500 user cards. This memory is divided into five user card groups, each of which holds a maximum of 100 user cards.

For a simple installation, all of a company's users (up to 100) can be put into the same user card group. Alternately, they can be split between two or more groups to make it easier to delete an entire group's user cards at once. For instance, user cards given to a group of temporary workers could be programmed into their own user card group. All the cards in that group can then be deleted once the workers leave.

Step	Action	Reaction
1	Tap the master card 1 time	Blue status LED flashes, and LED 1 flashes once
2	Wait 2 seconds	2 Beeps, then LEDs 1 through 5 flash
3	Press the "Bell" button one or more times to choose a user card group from 1 to 5	The LED corresponding to the chosen user groups turns to a steady ON to indicate that the user group is ready to receive user card codes; if the LED flashes, that user card group is full and cannot accept new cards
4	Wait 2 seconds	2 Beeps
5	Tap a blank user card 1 time	2 Beeps
6	To add multiple user cards, repeat step 5, or steps 3-5 to add to other groups	2 Beeps for each card confirms that the card was programmed into the reader
7	Exit programming by tapping the master card once	2 Beeps

NOTE: Once a user card has been programmed into the reader, it cannot be added to the same or another user card group. A long beep indicates that the user card is in use and will not be added a second time.

Advanced Programming (continued):

Deleting User Cards:

There are three ways to delete user cards:

1. Delete a single user card.
2. Delete a lost user card.
3. Delete a group of user cards.

Deleting a Single User Card:

Step	Action	Reaction
1	Tap the master card 2 times	Blue status LED flashes, and LED 2 flashes once
2	Wait 2 seconds	2 Beeps, then LEDs 1, 2, and 3 flash
3	Press the "Bell" button once	LED 1 turns to a steady ON
4	Wait 2 seconds	2 Beeps
5	Tap the user card to be deleted once	The card's user group LED flashes once for 1 second; 2 Beeps
6	To delete multiple user cards, repeat step 5	The card's user group LED flashes once for 1 second; 2 Beeps
7	Exit programming by tapping the master card once	2 Beeps

Deleting a Lost User Card:

A specific lost user card can only be deleted if the owner of the proximity card reader has kept careful records of each user card number and the user of that card. Deleting a particular user card requires the use of the user card which was programmed immediately prior to the lost user card. For example, if user card 7 in user group 3 was lost, to delete it, the administrator would need access to user card 6 in user group 3.

Step	Action	Reaction
1	Tap the master card 2 times	Blue status LED flashes, and LED 2 flashes once
2	Wait 2 seconds	2 Beeps, then LEDs 1, 2, and 3 flash
3	Press the "Bell" button twice	LED 2 turns to a steady ON
4	Wait 2 seconds	2 Beeps
5	Tap the user card which was programmed immediately before the lost user card once	The lost card's user group LED flashes once for 1 second; 2 Beeps
6	To delete multiple user cards, repeat step 5	The lost card's user group LED flashes once for 1 second; 2 Beeps
7	Exit programming by tapping the master card once	2 Beeps

NOTE 1: If user card 1 in a particular user group is lost, it can be deleted by using the super user card for that group.

NOTE 2: Any new user cards programmed into the reader will automatically fill any empty spots. For example, if user card 7 in user group 3 was deleted, the next new user card added to user group 3 will be the new user card 7.

Advanced Programming (continued):**Deleting an Entire User Group:**

Occasionally it may be necessary to delete an entire user group. For example, there may be a group of temporary users whose contract has ended, or several cards are lost and the administrator is not sure which cards to delete.

Step	Action	Reaction
1	Tap the master card 2 times	Blue status LED flashes, and LED 2 flashes once
2	Wait 2 seconds	2 Beeps, then LEDs 1, 2, and 3 flash
3	Press the "Bell" button three times	LED 3 turns to a steady ON to indicate that the reader is in the delete user group mode
4	Wait 2 seconds	2 Beeps; all five LEDs flash
5	Press the "Bell" button 1 to 5 times, corresponding to the user group to be deleted	The LED corresponding to the chosen user group turns to a steady ON to indicate that the group will be deleted
6	Wait 2 seconds	2 Beeps
7	Press the "Bell" button to confirm that the user group is to be deleted	The LED corresponding to the user group to be deleted flashes; 2 Beeps confirm deletion
8	To delete multiple user groups, repeat steps 5-7	2 Beeps for each user group confirm that the group was deleted.
9	Exit programming by tapping the master card once	2 Beeps

Programming the Door Unlock Mode:

The door unlock output can be programmed for one of two modes:

1. Toggle output
2. Timed output (1~60 sec)

NOTE: The factory default setting is timed output (2 sec).

To program the reader for toggle:

Step	Action	Reaction
1	Tap the master card 3 times	Blue status LED flashes, and LED 3 flashes once
2	Wait 2 seconds	2 Beeps, then LEDs 1 and 2 flash
3	Press the "Bell" button once	LED 1 turns to a steady ON to indicate that the door lock output is in toggle mode
4	Wait 2 seconds	2 Beeps confirm that toggle mode was set
5	Exit programming by tapping the master card once	2 Beeps

Advanced Programming (continued):

Programming the Door Unlock Mode (cont.):

To program the reader for timed output mode:

Step	Action	Reaction
1	Tap the master card 3 times	Blue status LED flashes, and LED 3 turns to a steady ON
2	Wait 2 seconds	2 Beeps, then LEDs 1 and 2 flash
3	Press the "Bell" button twice	LED 2 turns to a steady ON to indicate that the door lock output is in timed output mode
4	Wait 2 seconds	2 Beeps confirms that timed output mode was set
5	Press the "Bell" button once to start a 60-second timer	Count the number of beeps – 1 beep equals 1 second of door unlock time; count until the number of seconds required is reached
6	Press the "Bell" button again to stop the 60-second timer	Beeps stop; the door unlock time has been set
7	Exit programming by tapping the master card once	2 Beeps

Programming System Lockout:

The ENFORCER PR-312S-PQ Indoor Proximity Card Reader can be programmed to temporarily lock out user cards if non-programmed user cards are used. There are three possible modes:

1. No system lockout (default mode) (option 1)
2. Stop accepting user cards for 60 seconds after 10 false tries (option 2)
3. Stop accepting user cards for 15 minutes after 10 false tries (option 3)

Step	Action	Reaction
1	Tap the master card 4 times	Blue status LED flashes, and LED 4 turns to a steady ON
2	Wait 2 seconds	2 Beeps, then LEDs 1, 2, and 3 flash
3	Press the "Bell" button once for option 1, twice for option 2, or three times for option 3	LED 1 turns to a steady ON to confirm option 1 is set LED 2 turns to a steady ON to confirm option 2 is set LED 3 turns to a steady ON to confirm option 3 is set
4	Wait 2 seconds	2 Beeps confirms that the selected lockout mode was set
5	Exit programming by tapping the master card once	2 Beeps

NOTE: When using a user card to unlock the door, if more than 30 seconds pass after a false trial, the 10-trial counter restarts.

Advanced Programming (continued):

Creating/Deleting Super User Cards:

The ENFORCER PR-312S-PQ Proximity Card Reader can be programmed to read up to five super user cards, one for each of the five user groups. The super user cards can be used for the following tasks:

1. Disable the card reader for times when no one is expected inside the protected premises.
2. Return card reader to normal operation.
3. Unlock the door connected to the card reader regardless of whether it is enabled or disabled.

If a user group already has a super user card associated with it, programming a new super user card will automatically delete the old one.

To program a super user card:

Step	Action	Reaction
1	Tap the master card 5 times	Blue status LED flashes, and LED 5 flashes once
2	Wait 2 seconds	2 Beeps, then LEDs 1 and 2 flash
3	Press the "Bell" button once	LED 1 flashes once
4	Wait 2 seconds	2 Beeps, then LEDs 1 through 5 start to flash
5	Press the "Bell" button 1 to 5 times to choose a user group	The LED corresponding to the super user's assigned group turns to a steady ON
6	Wait 2 seconds	2 Beeps
7	Tap a currently unused user card	2 Beeps
8	For multiple super user cards, repeat steps 5-7.	2 Beeps for each card confirms that the card was programmed into the reader
9	Exit programming by tapping the master card once	2 Beeps

NOTE: When a new super user card has been programmed, immediately label it as a super user card and mark which user group it belongs to.

Advanced Programming (continued):

To delete a super user card:

Step	Action	Reaction
1	Tap the master card 5 times	Blue status LED flashes, and LED 5 flashes once
2	Wait 2 seconds	2 Beeps, then LEDs 1 and 2 flash
3	Press the "Bell" button twice	LED 2 turns to a steady ON to indicate that the reader is in the delete super user mode
4	Wait 2 seconds	2 Beeps; all five LEDs flash to indicate that the reader is ready to delete a super user card
5	Press the "Bell" button 1 to 5 times to choose a user group	The super user card's user group LED turns to a steady ON
6	Wait 2 seconds	2 Beeps
7	Press the "Bell" button once	2 Beeps confirm that the super user card was deleted
6	Exit programming by tapping the master card once	2 Beeps

NOTE: After deleting a super user card, that card may be reused like any blank card.

Troubleshooting:

The LEDs do not light	<ul style="list-style-type: none"> • Check the power connection • Check the power supply
The relay does not activate	<ul style="list-style-type: none"> • Make sure you are using a valid user card • Make sure the relay is not in toggle mode • Make sure the correct relay output is being used (either N.O. or N.C.)
The relay time is too short	<ul style="list-style-type: none"> • Set a longer door-release time
The egress button is not working	<ul style="list-style-type: none"> • Make sure you are using a N.O. switch • Double-check the door-release time • Double-check the relay toggle mode

ENFORCER Indoor Proximity Card Reader

Also Available from **SECO-LARM®**:



Stand-Alone Proximity Card Reader
PR-112S-A



Sealed-Housing Keypad with Built-in Proximity Card Reader
SK-1323-SPQ



Mullion-Style Keypad with Built-in Proximity Card Reader
SK-2323-SPQ



1,200-lb Single-Door Electromagnetic Lock
E-941SA-1200



Request-to-Exit Plate with 2" Square Button
SD-7202GC-PEQ



Piezoelectric Mullion-Style Keypad with Built-in Proximity Card Reader
SK-2323-SPAQ

FCC COMPLIANCE STATEMENT

FCC ID: K4E312SPQ

THIS DEVICE COMPLIES WITH PART 15 OF THE FCC RULES. OPERATION IS SUBJECT TO THE FOLLOWING TWO CONDITIONS: (1) THIS DEVICE MAY NOT CAUSE HARMFUL INTERFERENCE AND (2) THIS DEVICE MUST ACCEPT ANY INTERFERENCE RECEIVED, INCLUDING INTERFERENCE THAT MAY CAUSE UNDESIRE OPERATION.

Notice: The changes or modifications not expressly approved by the party responsible for compliance could void the user's authority to operate the equipment.

IMPORTANT NOTE: To comply with the FCC RF exposure compliance requirements, no change to the antenna or the device is permitted. Any change to the antenna or the device could result in the device exceeding the RF exposure requirements and void user's authority to operate the device.

WARRANTY: This SECO-LARM product is warranted against defects in material and workmanship while used in normal service for one (1) year from the date of sale to the original customer. SECO-LARM's obligation is limited to the repair or replacement of any defective part if the unit is returned, transportation prepaid, to SECO-LARM. This Warranty is void if damage is caused by or attributed to acts of God, physical or electrical misuse or abuse, neglect, repair or alteration, improper or abnormal usage, or faulty installation, or if for any other reason SECO-LARM determines that such equipment is not operating properly as a result of causes other than defects in material and workmanship. The sole obligation of SECO-LARM and the purchaser's exclusive remedy, shall be limited to the replacement or repair only, at SECO-LARM's option. In no event shall SECO-LARM be liable for any special, collateral, incidental, or consequential personal or property damage of any kind to the purchaser or anyone else.

NOTICE: The information and specifications printed in this manual are current at the time of publication. However, the SECO-LARM policy is one of continual development and improvement. For this reason, SECO-LARM reserves the right to change specifications without notice. SECO-LARM is also not responsible for misprints or typographical errors.

Copyright © 2014 SECO-LARM U.S.A., Inc. All rights reserved. This material may not be reproduced or copied, in whole or in part, without the written permission of SECO-LARM.

SECO-LARM® U.S.A., Inc.

16842 Millikan Avenue, Irvine, CA 92606

Phone: (949) 261-2999 | (800) 662-0800

Website: www.seco-larm.com

Email: sales@seco-larm.com

PIHAK1

MIPR-312S-PQ_141111.docx